



■ **atalogue-Middle East**





Contents

Company Introduction

02-03 ONSTAR GmbH



01 OFFICE LIGHTING

02 RETAIL LIGHTING

03 INDUSTRIAL LIGHTING

01 MILESTONE

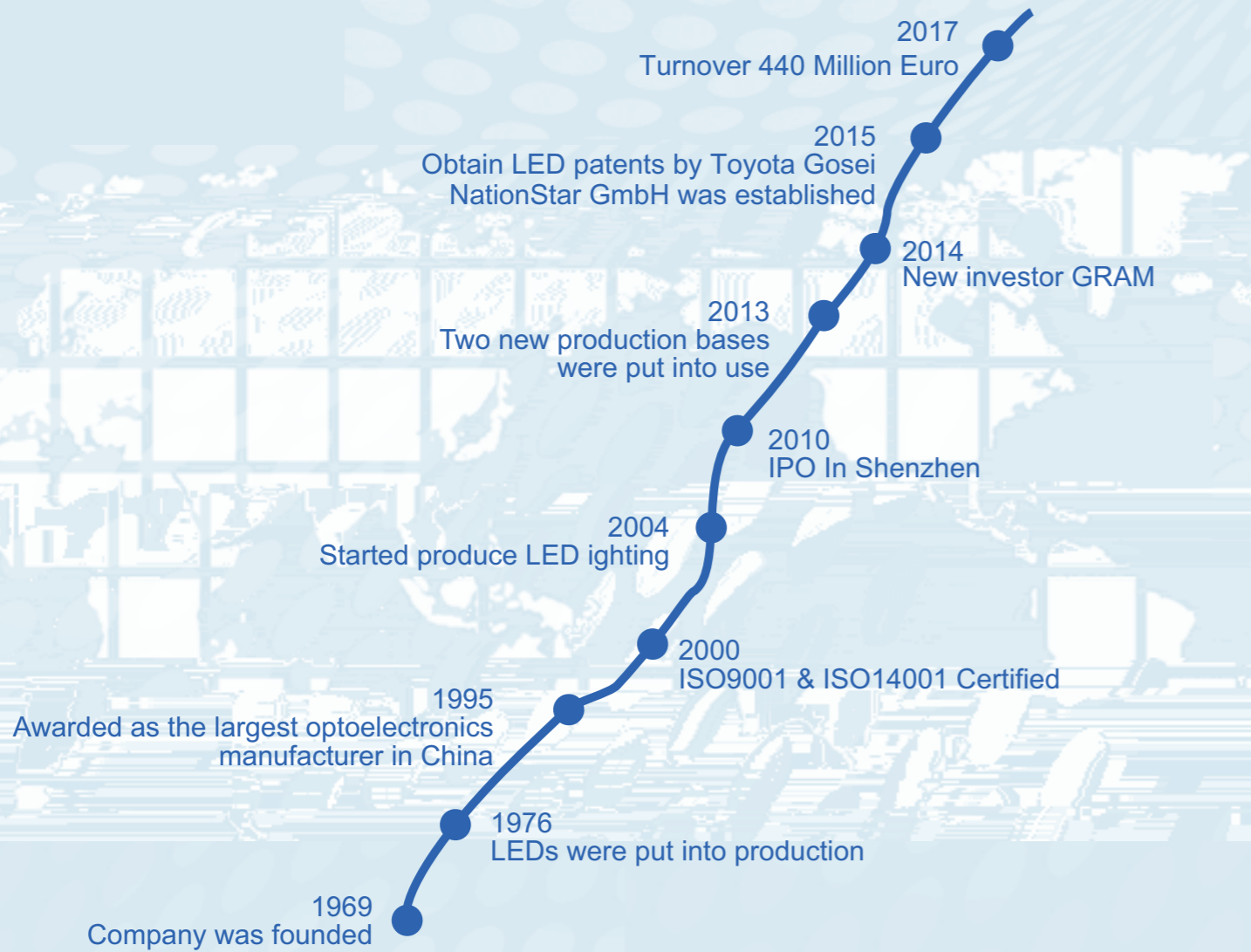

02 PRODUCTION CAPACITY

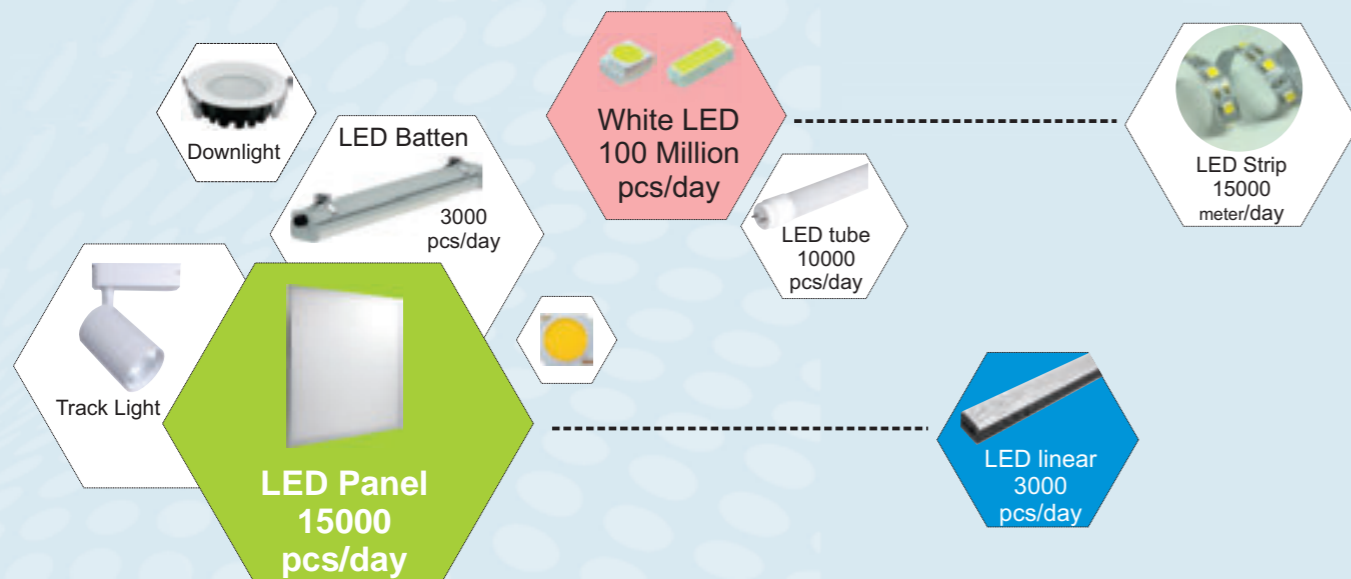

03 BRIEF INTRODUCTION

Foshan NationStar Optoelectronics Co.,Ltd has been specializing in LED industry for over 30 years, and started LED lighting manufacturing since 2004. With a strong R&D ability, reliable product quality and excellent after-sales service, NationStar becomes a leading manufacturer for chips, LEDs and LED lighting products.



The Northern Area of The Headquarter

Land area: 26,000 sqm.
Plant for LED components and devices

The Southern Area of The Headquarter

Land area: 34,600 sqm.
Production for LED and lighting products
Production capacity of LEDs: 4,000KK per month



Foshan NationStar Semiconductor Co.,Ltd.

Land area: 32,000 sqm.
The production base of GaN LED chips for lighting



04 INDUSTRIAL CHAIN



Chip



LED



Lighting



Office Lighting

AC230V

120°

IP20

No Flicker
Optional

0-10V
Optional

DALI
Optional

Motion Sensor
Available

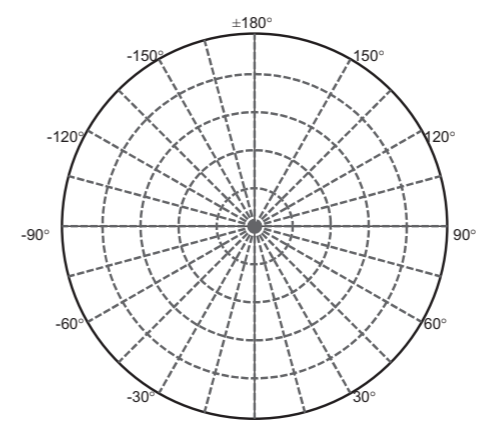

0

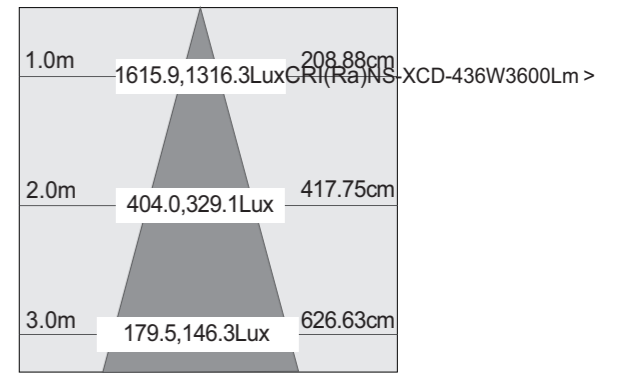
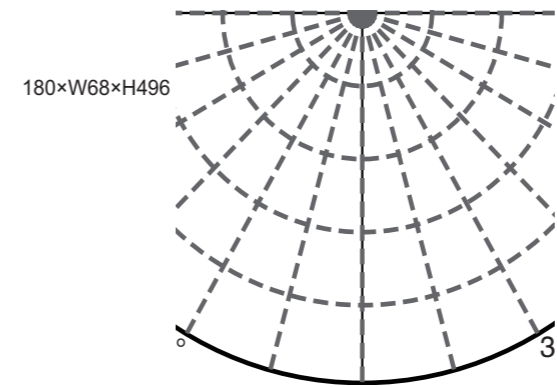



LED Tube T8 Glass

DIMENSIONS

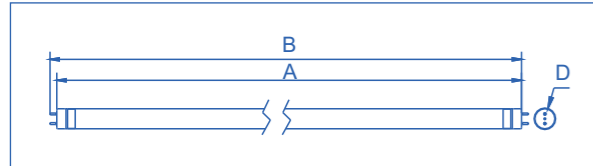

Length	A		B		D
	Max	Min	Max	Max	
0.6m	589.8	594.5	596.9	596.9	Ø26
0.9m	894.6	899.5	901.5	901.5	Ø26
1.2m	1199	1204.5	1206.5	1206.5	Ø26
1.5m	1499	1505	1507	1507	Ø26



TECHNICAL PARAMETERS

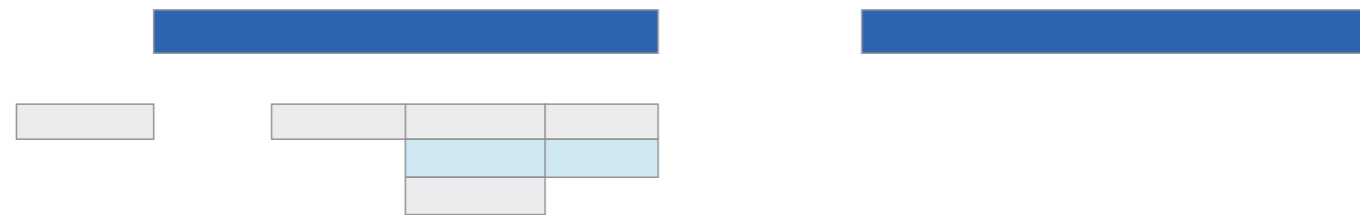

Lumen&Wattage: Type value with +/-10% tolerance.
Lamps must be approved for use in "open " luminaries.



LED Track Light

COB 25W 15° Photometric / Luminance

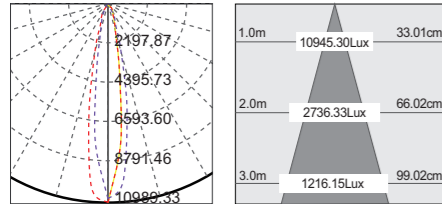

COB 25W 24° Photometric / Luminance

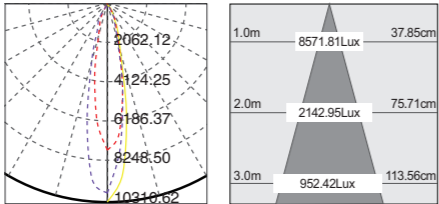

COB 25W 40° Photometric / Luminance

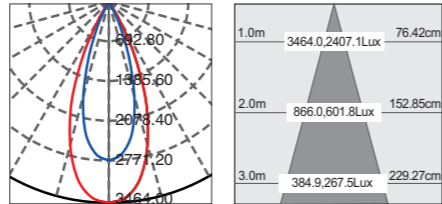

COB 35W 15° Photometric / Luminance

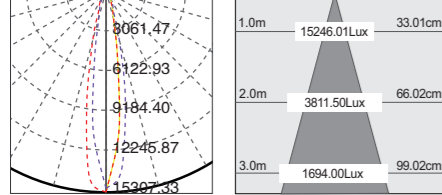

COB 35W 24° Photometric / Luminance

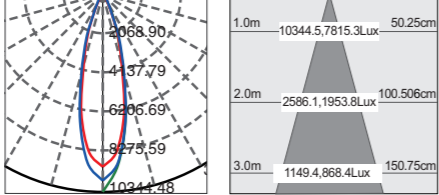

COB 35W 40° Photometric / Luminance

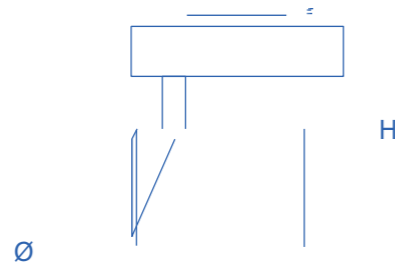
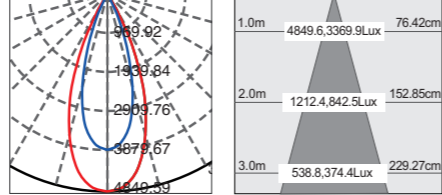

UNIT:mm

** Lumen&Wattage: Type value with +/-10% tolerance.

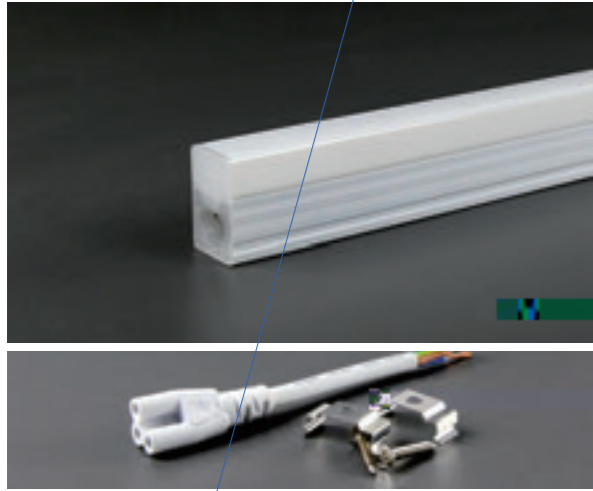

LED Batten T5



FEATURES

- Ultra bright SMD LED as light source;
- Can be connected with each other with connectors;
- All-plastic holder.

DIMENSIONS

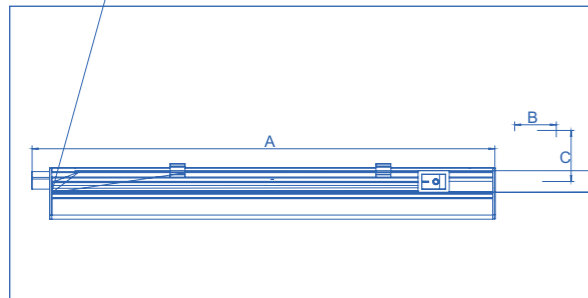

Length	A	B	C
0.3m	273	34.5	21.5
0.6m	573	34.5	21.5
0.9m	873	34.5	21.5
1.2m	1173	34.5	21.5

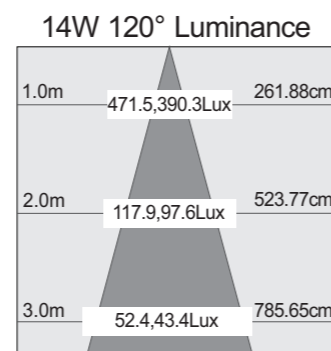
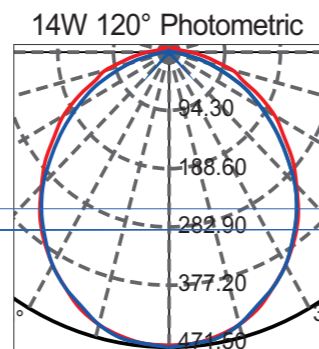

** Lumen&Wattage: Type value with +/-10% tolerance.

LED Downlight



FEATURES

- Low decay, high efficiency and high brightness SMD LED.
- Body in superior die-cast aluminium with polyester powder coating, non-discolouring;
- External independent regulatory power supply, high electrical efficiency, ensure long usage life.

LED COB Downlight



LED SMD Downlight



FEATURES

- Low decay, high efficiency and high brightness SMD LED;
- Delicate and unique embedded design;
- Low power consumption, long lifespan, reliable and safe;
- Built-in driver design.

TECHNICAL PARAMETERS

Order number	Input voltage (V)	Wattage (W)	Dimension (mm)	Cut-out (mm)	Lumen (Lm)	CRI (Ra)	CCT(K)
NS-TD2.5-P4F	AC230	4	Ø88×H50	Ø70	280	> 80	3000/4000/6500
NS-TD3-P7F	AC230	7	Ø115×H55	Ø100	420	> 80	3000/4000/6500
NS-TD4-P10F	AC230	10	Ø146×H70	Ø125	700	> 80	3000/4000/6500
NS-TD6-P15F	AC230	15	Ø193×H92	Ø150	1050	> 80	3000/4000/6500



LED Batten IP65

(On/Off Version)



FEATURES

- Design-oriented, plastic opal diffuser
- Impact protection: IK08
- Replacement for fluorescent lamp
- Microwave-sensor/DALI dimming/emergency
- IP65 Fixture
- Application: garage, basement, corridor

40W 120° Photometric

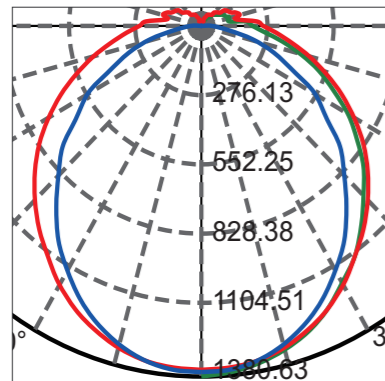

40W 120° Luminance

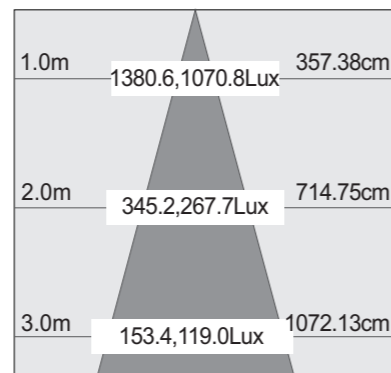

DIMENSIONS

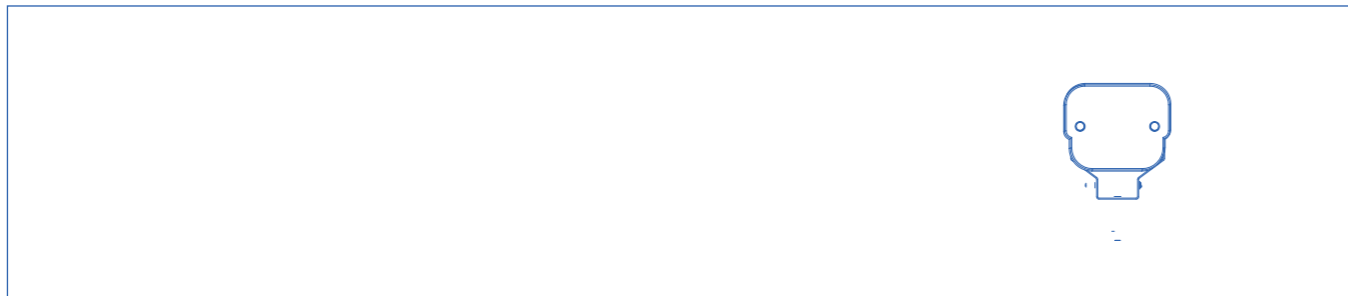

TECHNICAL PARAMETERS

Series	Order number	Input voltage(V)	Wattage(W)	Dimension (mm)	Lumen(Lm)	CCT(K)
NS-TPL-2A30		AC 230	30	600×77×62	3000	3000/4000/6500
NS-TPL-4A40		AC 230	40	1200×77×62	4000	3000/4000/6500
NS-TPL-5A60		AC 230	60	1500×77×62	6000	3000/4000/6500

** Lumen&Wattage: Type value with +/-10% tolerance.

SMD Flood Light

FEATURES

FEATURES

- Aluminum fitting;
 - Aluminum reflector;
 - Glass cover, IP65, SMD;
 - Working temperature: -20°C to 40°C;
- Your optimal outdoor parter Outdoor flood light is an amazing design, with low cost and safety;
This product can replace metal halide flood light.



Decorative Lighting

DC24V/
AC230V IP20/IP65/IP67



LED Strip IP20 NS-A3528 Series

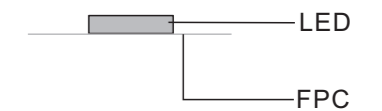

FEATURES

- High Brightness SMD2835
- Strips can be cut on the cutting mark and reconnect
- Standard PCB color: White
- Led Option: Mac Adam 3 or 5 step
- CRI 80/90
- 3M Adhesive Backing

TECHNICAL PARAMETERS

Order number	LED Qty (pcs/m)	Wattage (W/m)	LUMEN (Lm/m*Ra80)	Length (Meter/Reel)	Strip width (mm)	Maximum connection length (M)	CCT (K)	CRI (Ra)
NS-A3528RW60-24	60	5	480	10	8	10	2700	>80/90
NS-A3528WW60-24	60	5	500	10	8	10	3000	>80/90
NS-A3528NW60-24	60	5	520	10	8	10	4000	>80/90
NS-A3528CW60-24	60	5	520	10	8	10	6500	>80/90
NS-A3528RW60-24H	60	12	980	10	10	8	2700	>80/90
NS-A3528WW60-24H	60	12	1020	10	10	8	3000	>80/90
NS-A3528NW60-24H	60	12	1100	10	10	8	4000	>80/90
NS-A3528CW60-24H	60	12	1100	10	10	8	6500	>80/90
NS-A3528RW120-24	120	12	1050	10	8	6	2700	>80/90
NS-A3528WW120-24	120	12	1080	10	8	6	3000	>80/90
NS-A3528NW120-24	120	12	1200	10	8	6	4000	>80/90
NS-A3528CW120-24	120	12	1200	10	8	6	6500	>80/90
NS-A3528RW120-24H	120	24	1960	10	10	4	2700	>80/90
NS-A3528WW120-24H	120	24	2040	10	10	4	3000	>80/90
NS-A3528NW120-24H	120	24	2160	10	10	4	4000	>80/90
NS-A3528CW120-24H	120	24	2160	10	10	4	6500	>80/90
NS-A3528RW240-24	240	20	1920	10	12	5	2700	>80/90
NS-A3528WW240-24	240	20	2000	10	12	5	3000	>80/90
NS-A3528NW240-24	240	20	2050	10	12	5	4000	>80/90
NS-A3528CW240-24	240	20	2050	10	12	5	6500	>80/90

** Lumen: Type value with +/-10% tolerance.



LED Strip

IP65 NS-D3528 Series

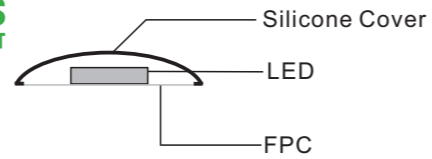

FEATURES

- High brightness SMD2835
- Strips can be cut on the cutting mark and reconnect
- Standard PCB color: White
- Led option: Mac Adam 3 or 5 step
- CRI 80/90
- 3M adhesive backing

TECHNICAL PARAMETERS

Order number	LED Qty (pcs/m)	Wattage (W/m)	LUMEN (Lm/m*Ra80)	Length (Meter/Reel)	Strip Width (mm)	Maximum connection length (M)	CCT (K)	CRI (Ra)
NS-D3528RW60-24	60	5	460	5	9	10	2700	>80/90
NS-D3528WW60-24	60	5	480	5	9	10	3000	>80/90
NS-D3528NW60-24	60	5	500	5	9	10	4000	>80/90
NS-D3528CW60-24	60	5	500	5	9	10	6500	>80/90
NS-D3528RW60-24H	60	12	950	5	11	8	2700	>80/90
NS-D3528WW60-24H	60	12	975	5	11	8	3000	>80/90
NS-D3528NW60-24H	60	12	1050	5	11	8	4000	>80/90
NS-D3528CW60-24H	60	12	1050	5	11	8	6500	>80/90
NS-D3528RW120-24	120	12	1000	5	9	6	2700	>80/90
NS-D3528WW120-24	120	12	1050	5	9	6	3000	>80/90
NS-D3528NW120-24	120	12	1100	5	9	6	4000	>80/90
NS-D3528CW120-24	120	12	1100	5	9	6	6500	>80/90
NS-D3528RW120-24H	120	24	1900	5	11	4	2700	>80/90
NS-D3528WW120-24H	120	24	2000	5	11	4	3000	>80/90
NS-D3528NW120-24H	120	24	2100	5	11	4	4000	>80/90
NS-D3528CW120-24H	120	24	2100	5	11	4	6500	>80/90
NS-D3528RW240-24	240	20	1860	5	13	5	2700	>80/90
NS-D3528WW240-24	240	20	1920	5	13	5	3000	>80/90
NS-D3528NW240-24	240	20	2000	5	13	5	4000	>80/90
NS-D3528CW240-24	240	20	2000	5	13	5	6500	>80/90

** Lumen: Type value with +/-10% tolerance.



LED Strip

IP65

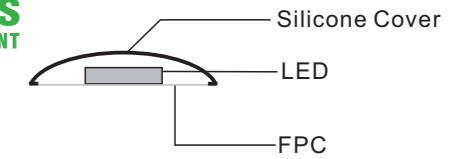

FEATURES

- High luminous flux;
- Anti-vulcanization;
- Waterproof with PVC casing, Water Proof classes: IP65;
- This product is perfect for tight and curved places;
- It takes the shape of the place which you want to light like racks lighting in stores.

TECHNICAL PARAMETERS

Order number	LED Type	LED Qty (pcs/m)	Wattage (W/m)	Length (Meter/Reel)	Strip Width (mm)	Maximum connection length (M)	CCT (K)	CRI (Ra)
2835-180-220V-XW	2835	180	8	5	12	10	3000/4000/6000	>80
5050-60-220V-RGB	5050	60	10	5	10	10	RGB	>80

Accessories for Non-waterproof/ IP20 LED Strip

LED Strip In Line Dimmer

- 0-100% Dimming
- Can only be used in DC12/24V
- For indoor use only



RGB Controller

- Must be used with RGB LED strips
- With remote controller
- Adjusts speed and brightness
- Connects between power supply and strips



Power Feed

- Connects strips to power supply



RGB Power Supply Leads

- Connects strips to power supply
- Power supply



Power Feed

- Connects strips to power supply



RGB Power Supply Leads

- Connects strips to power supply



Single Color Connectors

Inline Splice

- Connects 2 sections of the strips together



RGB Connectors

Inline Splice

- Connects 2 sections of the strips together



Interconnect Cable

- Connects 2 sections of the strips together



Interconnect Cable

- Connects 2 sections of the strips together



3-Way Connector

- Connects 3 sections of the strips together
- One input, two outputs
- Ideal for making "T" & "Y" connections



RGB 3-Way Connector

- Connects 3 sections of the strips together
- One input, two outputs
- Ideal for making "T" & "Y" connections



4-Way Connector

- Connects 4 sections of the strips together
- One input, three outputs



RGB 4-Way Connector

- Connects 4 sections of the strips together
- One input, three outputs



Single Color Connectors

Interconnect Cable

- Connects 2 sections of the strips together



3-Way Connector

- Connects 3 sections of the strips together
- One input, two outputs
- Ideal for making "T" & "Y" connections



4-Way Connector

- Connects 4 sections of the strips together
- One input, three outputs



End Cap

- Terminal for the strips



Silicone

- Silicone glue for the end cap



RGB Connectors

Interconnect Cable

- Connects 2 sections of the strips together



RGB 3-Way Connector

- Connects 3 sections of the strips together
- One input, two outputs
- Ideal for making "T" & "Y" connections



RGB 4-Way Connector

- Connects 4 sections of the strips together
- One input, three outputs



Outdoor Power Supply



Clips

- Fix the strips on the surface



